

Space Heater 500[™]

500 Series Module

Tube Drive



User Guide

Radial Engineering Ltd.
1588 Kebet Way, Port Coquitlam, British Columbia, Canada, V3C 5M5
Tel: 604-942-1001 • Fax: 604-942-1010 • Email: info@radialeng.com

Radial® Space Heater 500™ User Guide

Table of Contents	Page
Warning	1
Feature set	2
Overview	3
Making connections	4
The control panel	5
Using the filters	6
Using the Space Heater 500	7
Applications	8
Block diagram and specifications	9
Warranty	Back cover

Congratulations... Thank you for joining the growing number of Radial 500 series module users. The Space Heater 500™ will be a truly unique and useful addition to your recording studio setup. Although its standard operation and connections are no different than any other 500 series module, we recommend that you take a few minutes to read through this manual and familiarize yourself with the design and controls.

Should you have any questions on an application not covered in this manual, we invite you to log onto the Radial Engineering website at radialeng.com to check the Space Heater 500's FAQ section for the latest updates. If you still do not find what you are looking for, feel free to send us an email at info@radialeng.com.

Now lets warm things up and embrace the distortion!



Warning Notice to User!

The Space Heater 500™ is a high-voltage tube device designed for professional use only. Although preventative safety measures have been designed into Radial 500 series products, we strictly advise against hot-swapping modules or plugging and unplugging them while your Workhorse or other 500 series rack is powered. Hot-swapping can cause connection shorts at the card-edge connector that could damage other equipment. This also greatly reduces the life span of the contacts. Damage due to hot-swapping is not covered under warranty.

The 12AX7 tube inside the Space Heater 500™ can be removed and replaced as required. Opening the unit should only be performed by a qualified technician familiar with 500 Series modules or by those experienced with replacing tubes.

FEATURE SET

1. **DRIVE:** Controls the input level of the tube circuit. Increase the drive to allow more signal to enter the tube adding saturation and warmth.
2. **HEAT:** 3-position switch selects between 35, 70 and 140 volts at the tube. At 35V the tube is starved for voltage creating more distortion.
3. **LEVEL:** Controls overall output level. Depending on the amount of drive added, the level control can be adjusted to achieve an optimal signal level.
4. **HI-CUT:** The low-pass filter is used to tame excessive harmonics when using heavy distortion.
5. **EQ:** Assigns the filters pre or post tube circuit, or turns them off completely.
6. **LOW-CUT:** Variable high-pass filter from 5Hz to 500Hz used for reducing unwanted low frequencies.
7. **ON:** Engage or bypass the circuit completely.
8. **OMNIPORT:** Available when used with the Radial Workhorse, the Omniport accesses a hi-Z instrument input.
9. **POWER ASSIGN SWITCH:** Lets you toggle the input supply from the positive or negative rail. This enables multiple Space Heaters to be used together without power sag.
10. **12AX7 TUBE:** The Space Heater 500 employs a select low-noise 12AX7 tube with a non-radiating 140V charge pump to deliver the performance of a high voltage tube preamp.

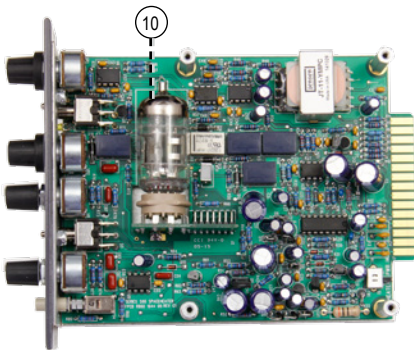

OVERVIEW

The Space Heater 500 is a studio-grade tube overdrive and distortion unit in a 500 series. Think of it as a 12AX7 tube distortion pedal designed for professional recording. It's versatile controls and high-grade signal path make it useable in a variety of ways.

The signal path begins at the 12AX7 tube. A HEAT switch allows you to select between three different tube voltage levels. An adjustable DRIVE control sets the input level to the tube while a LEVEL control acts as a master output fader. Adjusting the balance between DRIVE and LEVEL allows you to tailor the sound from subtle analog warmth to over the top distortion. All of this is coupled with an oversized output transformer, bringing more vintage character and warmth to the signal path.

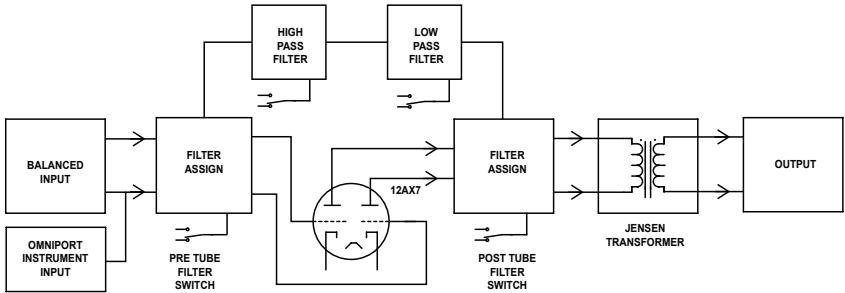

The Space Heater 500 also features variable high-pass (5Hz to 500Hz) and low-pass filters (500Hz to 20kHz). These filters can be assigned pre or post tube, allowing you to drive the circuit in different ways. Rolling off high or low frequencies before passing through a tube will cause it to produce a different distortion. Sometimes you want the tube to break up normally and roll off the unwanted frequencies later. And if you don't want the filters in the path at all, they can be bypassed.

When used with Radial's Workhorse™ 500 series racks, the Space Heater 500 supports Omniport functionality by becoming a hi-Z instrument input. Simply plug the instrument of your choice into the Omniport using an unbalanced 1/4" cable and adjust the Level and Drive controls to suit. This effectively turns the Space Heater 500 into an instrument preamp with a +4dBu line level output, suitable for driving power amps or for direct recording.

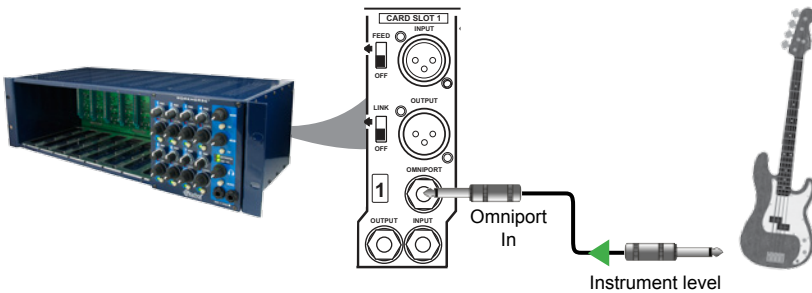

MAKING CONNECTIONS

Before making any connections, power down your 500 series rack and loudspeakers. Turn all level controls on your Space Heater 500 down to their lowest positions. This helps protect equipment (and your ears!) from damaging volume spikes during setup. Carefully plug the Space Heater 500 into your 500 series rack to avoid stress on the card-edge connector. Once properly seated, screw the module in place to ensure it does not become accidentally dislodged. Engage +48V phantom power on your 500 series rack so that the tube inside your Space Heater 500 will power up.

Connections between the Space Heater 500 and your recording system are made via the rear panel on your 500 series rack. Most 500 series racks are equipped with XLR connectors, but may also include D-Sub or ¼" TRS connectors. When you plug the Space Heater 500 into a 500 series rack, it will automatically route the input and output to the module.

The Space Heater 500 is a professional line level device that is designed for use with balanced +4dBu line level signals. To ensure proper performance, ensure that your recording system or audio interface is set up for professional line level inputs and outputs.

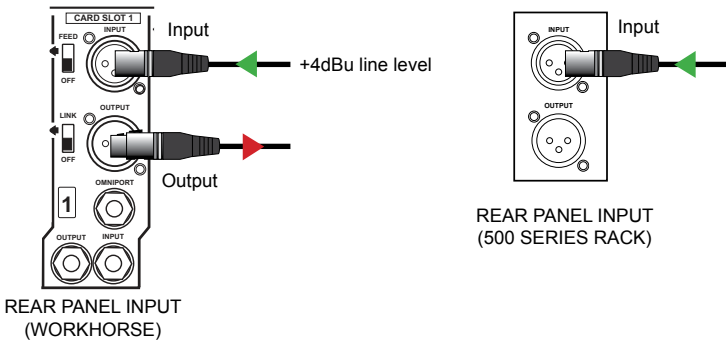

MANAGING POWER

The Space Heater 500 is equipped with a +/- power select switch next to the card-edge connector at the back of the module (only accessible out of the rack). This switches the tube's heater voltage from the positive to the negative power rail in the rack. If you are using several modules, it is possible that the combination can exceed the power available on one rail. By switching the rail source, you can free up un-tapped power for the Space Heater 500 or other modules that may be underperforming.

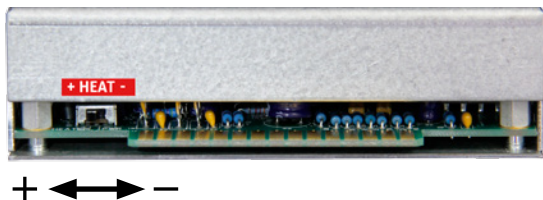
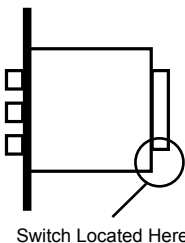

THE CONTROL PANEL

Once signal is running through the Space Heater 500, it is time to start having fun! The Space Heater 500 can be used for anything from slight analog warmth to full-out distortion reminiscent of a high-gain guitar amplifier. How you set the controls will greatly alter the output, so it is important to understand how each control effects the signal path.

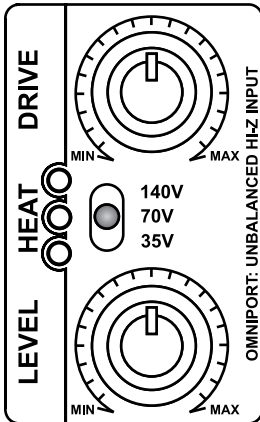

DRIVE

The DRIVE control sets the input level to the tube section. As you increase the DRIVE, more signal is allowed to enter the tube. More signal will drive the tube harder, pushing it into saturation and creating more distortion. Subtle harmonic saturation that we perceive as analog 'warmth' can be achieved by setting the Drive level very low. This has a result similar to compression, where the signal becomes more present in the mix but dynamics are retained. The opposite is to turn the DRIVE control all the way up, forcing lots of signal through the tube. This will allow the tube to behave like a traditional overdrive with a shredding distortion that can be fun to apply on any instrument. You will quickly find that even small adjustments to the DRIVE control will greatly change the output of the Space Heater 500, allowing for infinite tone shaping.

HEAT

The HEAT switch allows the user to adjust the B+ voltage of the tube. There are three selectable voltages: 35V, 70V and 140V. At 35 volts, the tube is starved for voltage. This will cause it to break up at very low levels, which makes it ideal when heavy, crushing distortion is desirable. 70 volts allows for more headroom before the tube starts to distort and provides moderate distortion as you apply more drive. At 140 volts, the tube will accept a lot more signal before breaking up. This allows you to warm things up slightly at low drive settings, or ramp it up to drive the tube with plenty of voltage, reminiscent of your favorite high-gain guitar amplifier. When first using the Space Heater 500, begin with the HEAT switch set at 70V. This medium setting makes it very easy to dial in the sound you are looking for and allows you to quickly audition the 35V and 150V settings.

LEVEL

The LEVEL control adjusts the overall output of the Space Heater 500. Depending on how you have the DRIVE control set, increasing or decreasing the LEVEL may be required for optimal signal levels. Adjusting the balance between these two controls is the quickest way to achieve your desired amount of distortion. All other controls can then be used to fine-tune the result.

IN / BYPASS

The Space Heater 500 is able to be completely bypassed when not needed. This removes the entire circuit from the signal chain.

USING THE FILTERS

EQ SELECTION

A 3-position EQ switch allows you to place the filter section before or after the tube, or turn it off completely. This allows the user to create frequency-specific distortion by applying the filters before the tube, causing it to break up differently. Inserting the filters after the tube section lets you create full-bandwidth distortion, then roll off what you don't want afterwards. Play around with the positioning to hear the difference in tone!

HI-CUT

The variable low-pass filter is active from 20kHz down to 500Hz. This filter can be very helpful in reducing high frequencies caused by heavy distortion.

LO-CUT

The variable high-pass filter is active from 5Hz to 500Hz. This is useful for rolling off unwanted low frequency resonance and cleaning up the bottom end.

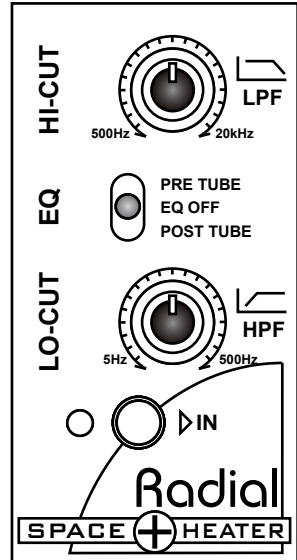

GETTING STARTED

The Space Heater 500 can be used on any source where analog warmth or harmonic distortion is desired. Like an analog EQ or compressor, the Space Heater 500 can be patched into your system as a hardware insert or used in-line with other hardware.

Start by setting up the Space Heater 500 controls as follows:

- 1 – DRIVE: set to the 12 o'clock position.
- 2 – HEAT: set to 70V (middle position).
- 3 – LEVEL: set to the 12 o'clock position.
- 4 – HI-CUT: set fully clockwise (20kHz).
- 5 – EQ: Set to OFF (middle position).
- 6 – LO-CUT: set fully counter-clockwise (5Hz).
- 7 – IN: push in to activate the circuit.

You should now be able to hear a subtle distortion when audio passes through the Space Heater 500. For optimal signal to noise performance, it is recommended that you adjust the LEVEL control to match the output of the dry signal. This can be quickly accomplished with the IN button. Press to activate, depress to bypass.

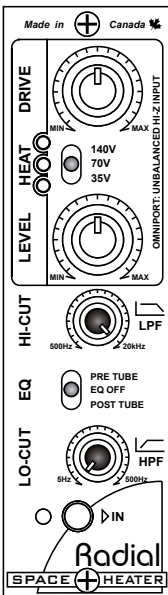

USING THE SPACE HEATER 500

DRUMS

The Space Heater 500 is a fantastic piece to add excitement and punch to a drum kit by inserting it on individual channels. Slowly bring up the distortion by increasing the DRIVE control, the audio will compress and become more present in the mix. Adding subtle distortion to a kick or heavy distortion to a snare is particularly effective as it is often difficult to increase the presence of these instruments without drastically increasing their level.

TIP: Try assigning the output of the Space Heater 500 to a different channel on your recorder. This will allow you to bring up the distorted track separately from the original clean track. Playing back the two channels in parallel will allow you to adjust the blend between the two, which will allow you to dial in your sound even more quickly!

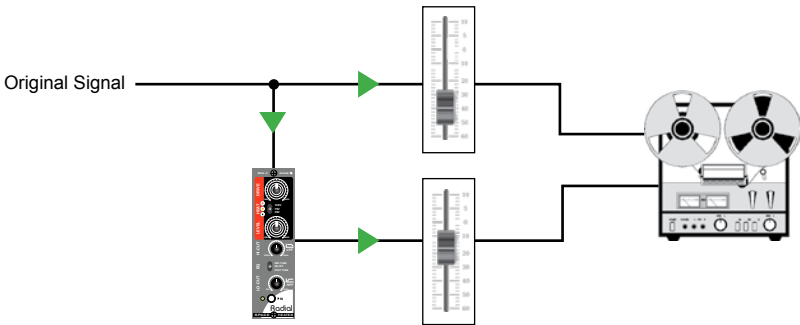

BASS

Bass guitar is an instrument that can definitely benefit from some grit. First, the Space Heater 500 can reduce the amount of compression needed as the distortion will add harmonics to the bass sound, effectively allowing it to live in a different frequency space that is not competing so closely with other instruments. Distortion can also help define bass frequencies in small speakers or headphones. Try applying a small amount of distortion with the Space Heater 500 while listening with headphones. Even if the change is inaudible in larger speakers, it can make all the difference when listening on small speakers.

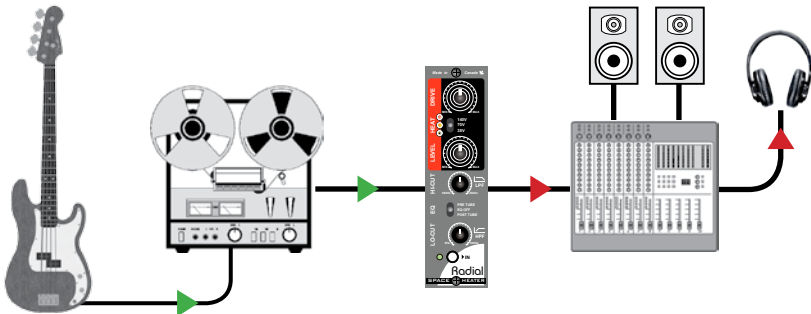

VOCALS

It is always a challenge to maintain a lead vocals presence in a mix, particularly in rock music where they are competing for space with distorted guitars. Guitar distortion tends to live in the same frequency space as the vocal, so turning up one will quickly mask the other. Using the Space Heater 500 to apply a small amount of distortion to the vocal can help the track move into a different frequency space, bringing clarity and definition without resorting to heavy-handed compression or drastic EQ.

ELECTRONIC MUSIC

Keyboards, synths and various tone generators will react differently when applying distortion. Experiment by running different signals and instruments through a channel on the Space Heater 500 and listen to the results. Try running a fixed frequency tone through the Space Heater 500 and listen to the results - The possibilities are endless!

GUITAR

Direct recorded electric guitars can often be too clean or shrill. Applying a slight distortion can make them sound more like they are coming out of a clean amp rather than a direct box. Turning up the distortion can make you quickly forget that the guitar was ever clean in the first place and leave others thinking that you recorded a tube powered half-stack!

DISTORTED DELAY OR REVERB

A bit of distortion on an EFX return can make your delays or reverbs sound quite a bit different than the dry recording. This makes the effect much more present in the mix, and can add a vintage character to your digital delay or reverb. Light distortion can mimic famous vintage analog gear, while a heavy distortion can transform a delay into a completely different effect.

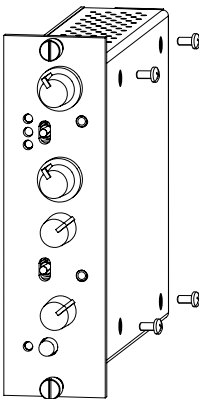

REPLACING THE TUBE

Step 1: Remove the top cover of the Space Heater. There are four Hex screws on the cover.

Step 2: Carefully wiggle the tube out of its socket. Be sure to apply even pressure to the base of the tube as you pull the tube out of its socket.

Step 3: Replace the tube by aligning the pins up with the socket. Tubes are 'keyed' so that they can only be installed in one position. Once aligned, carefully push the tube in by applying even pressure across the top of the tube.

Step 4: Re-install and fasten top cover.

CAUTION: THE SPACE HEATER IS A HIGH VOLTAGE DEVICE. TURN OFF THE UNIT AND DISCONNECT THE POWER SUPPLY FOR 10-15 MINUTES BEFORE ATTEMPTING TO CHANGE THE TUBES. THIS WILL ALLOW THEM TIME, TO COOL AND WILL REDUCE THE CHANCE OF ELECTRIC SHOCK BY GIVING THE SPACE HEATERS INTERNAL CAPACITORS TIME TO DISCHARGE.

BLOCK DIAGRAM*

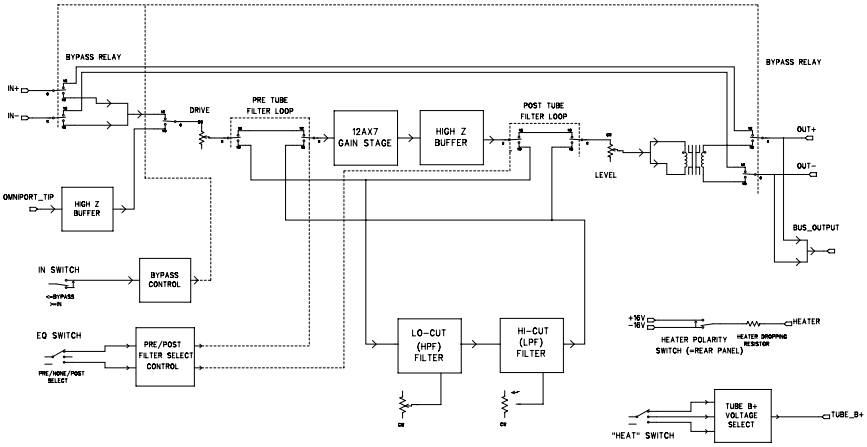

SPACE HEATER 500 MODULE SPECIFICATIONS*

- Audio circuit type: Thermionic gain stage with solid state input and output buffers
- Frequency response: 20Hz - 20KHz ± 1dB
- Total Harmonic Distortion: (THD+N)..... Varies with drive and level settings
- Dynamic range: 92dB
- Input impedance: 50K
- Input impedance: Instrument..... 1M
- Maximum input: +20dBu
- Maximum gain: 32dB @ 140V / 27dB @ 70V / 13dB @ 35V
- Clip Level - Output..... +22dBu
- Output impedance: 100 Ohms
- Equivalent input noise: -102dBu
- Noise floor: -70dBu
- Intermodulation distortion: Varies with drive and level settings
- Common Mode Rejection Ratio..... -60dB
- Omnipoint: Unbalanced instrument input
- Power requirement: 80mA
- Weight: 1.5lbs (0.7Kg)
- Size:..... 9 x 6.5 x 2 (inches)
- Warranty: 3 Years, transferable

* Subject to change without notice.

CONNECTOR WIRING

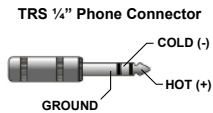
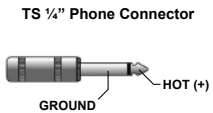
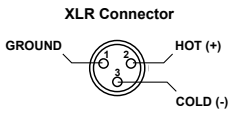

THREE YEAR TRANSFERABLE LIMITED WARRANTY

RADIAL ENGINEERING LTD. ("Radial") warrants this product to be free from defects in material and workmanship and will remedy any such defects free of charge according to the terms of this warranty. Radial will repair or replace (at its option) any defective component(s) of this product (excluding finish and wear and tear on components under normal use) for a period of three (3) years from the original date of purchase. In the event that a particular product is no longer available, Radial reserves the right to replace the product with a similar product of equal or greater value. In the unlikely event that a defect is uncovered, please call 604-942-1001 or email service@radialeng.com to obtain a RA number (Return Authorization number) before the 3 year warranty period expires. The product must be returned prepaid in the original shipping container (or equivalent) to Radial or to an authorized Radial repair centre and you must assume the risk of loss or damage. A copy of the original invoice showing date of purchase and the dealer name must accompany any request for work to be performed under this limited and transferable warranty. This warranty shall not apply if the product has been damaged due to abuse, misuse, misapplication, accident or as a result of service or modification by any other than an authorized Radial repair centre.

THERE ARE NO EXPRESSED WARRANTIES OTHER THAN THOSE ON THE FACE HEREOF AND DESCRIBED ABOVE. NO WARRANTIES WHETHER EXPRESSED OR IMPLIED, INCLUDING BUT NOT LIMITED TO, ANY IMPLIED WARRANTIES OF MERCHANTABILITY OR FITNESS FOR A PARTICULAR PURPOSE SHALL EXTEND BEYOND THE RESPECTIVE WARRANTY PERIOD DESCRIBED ABOVE OF THREE YEARS. RADIAL SHALL NOT BE RESPONSIBLE OR LIABLE FOR ANY SPECIAL, INCIDENTAL OR CONSEQUENTIAL DAMAGES OR LOSS ARISING FROM THE USE OF THIS PRODUCT. THIS WARRANTY GIVES YOU SPECIFIC LEGAL RIGHTS, AND YOU MAY ALSO HAVE OTHER RIGHTS, WHICH MAY VARY DEPENDING ON WHERE YOU LIVE AND WHERE THE PRODUCT WAS PURCHASED.

To meet the requirements of California Proposition 65, it is our responsibility to inform you of the following:

WARNING: This product contains chemicals known to the State of California to cause cancer, birth defects or other reproductive harm.

Please take proper care when handling and consult local government regulations before discarding.



This product is intended for professional use only.
The user should be familiar and experienced with
the 500 series rack and module format



www.radialeng.com

Made in Canada 

Radial Engineering Ltd.
1588 Keбет Way, Port Coquitlam BC V3C 5M5
tel: 604-942-1001 • fax: 604-942-1010
info@radialeng.com • www.radialeng.com

Radial® Space Heater 500™ Module User Guide - Part #: R870 1255 00 / 11-2016
Copyright 2015 Radial Engineering Ltd. All rights reserved.
Specifications and appearances subject to change without notice.

