

ADORN



SIGNATURE SOUND FOR COMMERCIAL
INSTALLATION APPLICATIONS

Unite Your Audience
The Martin Audio Experience



Martin Audio ADORN on-wall and ceiling loudspeakers bring class-leading performance, reliability and cost competitiveness to a wide range of commercial sound installations — from retail outlets, bars and restaurants to corporate offices.

With Martin Audio signature sound characteristics, the ADORN series is a perfect choice for background and foreground systems which require superior sound quality from visually-discreet, ultra-compact, yet value priced enclosures. They also provide a seamless sonic transition within a multi-zone complex using larger Martin Audio systems such as CDD or BlacklineX.



ADORN

FEATURES

- Contemporary, unobtrusive design
- High output capability
- High fidelity sound
- Low and high-frequency overload protection
- 70V/100V transformer options
- 5-year warranty

APPLICATIONS

- Retail outlets
- Cafes, bars and restaurant chains
- Hotels and convention centres
- Educational facilities
- Corporate offices

AESTHETIC ENCLOSURES

ADORN full-range on-wall enclosures are visually unobtrusive with smooth lines. Available in black or white as standard, they can be readily painted to match any interior décor and architectural environment.

ADORN in-ceiling and pendant speakers feature a bezel-less grille for a clean look and a bayonet fitting which is easy to remove without the use of tools. The in-ceiling series is finished in white and may also be painted to blend with any décor while the pendant is also available in black as standard.

LOW IMPEDANCE AND TRANSFORMER OPTIONS

All models have a nominal impedance of 16 ohms, enabling four or more speakers to be driven in parallel by one amplifier channel, thereby maximising efficiency and minimising cost.

All 'T' designated models are fitted with an internal high-quality 70V/100V multi-tap line transformer with a switch to select the output level.

OVERLOAD PROTECTION

For full-bandwidth protection, the low and high-frequency sections are individually protected against overload in all models.





ACS-40TS

Comprising a 4" (100mm) LF driver and a 0.75" (19mm) silk-dome tweeter, the ACS-40TS produces 108dB peak output at 1 metre and has a high-fidelity sonic character ideal for both music and speech reproduction. Its ported design delivers strong bass that extends down to 73 Hz.

The very wide 180° conical coverage of the ACS-40TS makes it particularly suitable for low ceilings and reduces the number of speakers required for even coverage — leading to a reduction in installation cost. It features a shallow backcan for installation in ceilings with a minimum cavity depth.



ACS-55TS

Comprising a 5.25" (135mm) LF driver and a 0.75" (19mm) silk-dome tweeter, the ACS-55TS produces 113dB peak output at 1 metre and has a high-fidelity sonic character ideal for both music and speech reproduction. Its ported design delivers strong bass that extends down to 79Hz.

The wide 150° conical coverage of the ACS-55TS makes it particularly suitable for low ceilings and reduces the number of speakers required for even coverage — leading to a reduction in installation cost. It features a shallow backcan for installation in ceilings with a minimum cavity depth.





ACS-55T

Comprising a 5.25" (135mm) LF driver and a 0.75" (19mm) silk-dome tweeter, the ACS-55T produces 113dB peak output at 1 metre and has a high-fidelity sonic character ideal for both music and speech reproduction. Its ported bass reflex design and backcan with generous internal volume maximises low frequency output and delivers strong bass that extends down to 62Hz.

The wide 150° conical coverage of the ACS-55T reduces the number of speakers required for even coverage — leading to a reduction in installation cost.



ACP-55T

Comprising a 5.25" (135mm) LF driver and a 0.75" (19mm) silk-dome tweeter, the ACP-55T produces 109dB peak output at 1 metre and delivers superb sound quality for both music and speech reproduction. Its stylish pendant enclosure is equipped with a single-point mounting system plus provision for attaching a safety cable.

The consistent and wide 150° conical coverage of the ACP-55T reduces the number of speakers required for even coverage — leading to a reduction in installation cost.



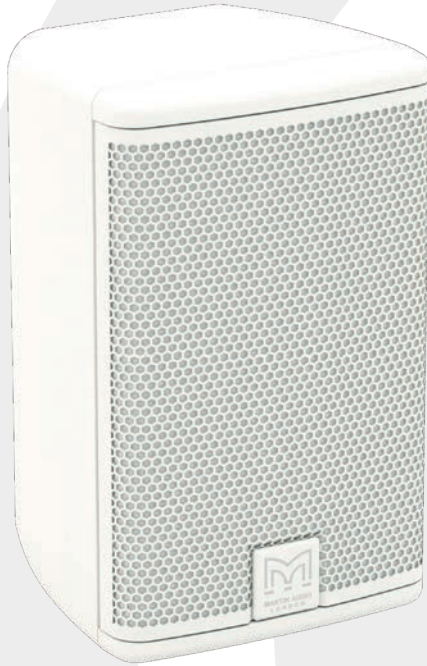

A40/A40T

The A40 is a two-way passive speaker with an elegant design that is perfect for architectural interiors that require high-fidelity sound from an unobtrusive, ultra-compact enclosure. Comprising a 4" (100mm) LF driver and a 0.75" (19mm) silk-dome HF driver on a 110° x 80° horn, it handles 40W AES, 160W peak and can produce 109dB peak output at 1 metre.

Its paintable ABS enclosure can be wall-mounted vertically or horizontally using the mounting bracket supplied. With a nominal impedance of 16 ohms, multiple speakers can be driven in parallel from a single channel of a low impedance amplifier such as the Martin Audio VIA2004. The A40T transformer option features a built-in 70V/100V multi-tap transformer for line operation. The enclosure is suitable for outdoor usage when used with the waterproof connector cover accessory (sold separately).

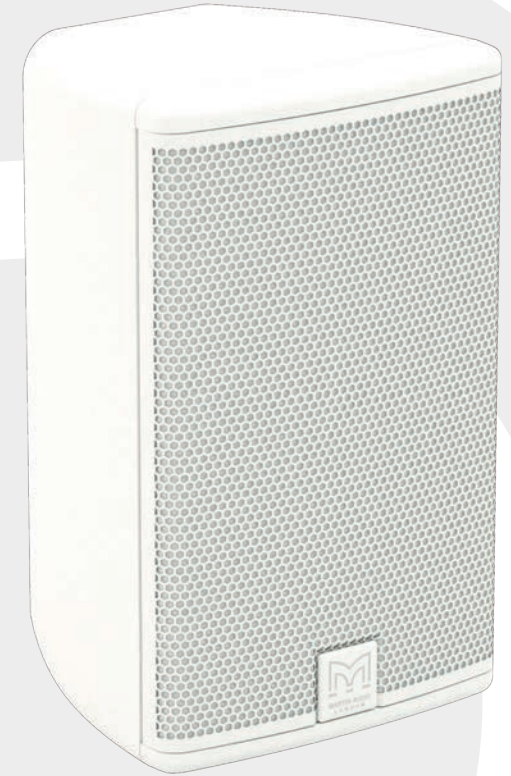

A55/A55T

The A55 features a 5.25" (135mm) LF driver and a 0.75" (19mm) silk-dome HF driver on a 110° x 80° horn. With a power handling of 50W AES, 200W peak, and a maximum SPL of 113dB at 1 metre, it is designed for background and foreground applications that call for premium sound quality and high levels from a visually-discreet enclosure.

It can be wall-mounted vertically or horizontally using the mounting bracket supplied and its nominal impedance of 16 ohms enables multiple speakers to be driven in parallel from a single channel of a low impedance amplifier such as the Martin Audio VIA2004. A transformer option, the A55T, with a built-in 70V/100V multi-tap transformer is available for line operation. The enclosure is suitable for outdoor usage when used with the waterproof connector cover accessory (sold separately).



SX110 SUBWOOFER

The SX110 subwoofer will extend the bandwidth of ADORN speakers and is ideal for foreground music applications which require increased impact and low frequency performance. Designed to be able to sit under banquette seating or discreetly placed within a venue, its ultra-compact enclosure features a 10" (250mm) driver and generous bass-reflex porting to reduce air noise.

The SX110 can also be suspended by means of integral M8 threaded inserts. It comes in black or white as standard.



VIA2004

VIA5002

RECOMMENDED AMPLIFIER AND CONTROLLER

For the ceiling speakers and for both the A40 and A55 the recommended amplifier is the Martin Audio VIA2004. This four channel high performance, cost effective power amplifier can also partner with the DX0.5 controller for small scale efficient installations, or with the DX4.0 controller for larger more complex installations, which could then also be managed by Martin Audio's VU-NET control software platform. For the A40T and A55T the recommended amplifier is the VIA5002 in conjunction with a suitable line transformer.



DX4.0



DX0.5

TECHNICAL SPECIFICATIONS

ACS-40TS

TYPE	Ultra-compact, passive two-way ceiling speaker, ported bass reflex
FREQUENCY RESPONSE (1)	106Hz-20kHz \pm 3dB, -10dB @ 73Hz
DRIVERS	LF: 4" /1" high-temp voice coil, coated paper cone, rubber surround, ferrite motor, pressed steel chassis HF: 0.75" silk dome, neodymium motor
RATED POWER (2)	40W AES, 160W peak
RECOMMENDED AMPLIFIER	VIA2004 (for low-impedance operation)
SENSITIVITY (4)	86dB / 1W(4V) / 1m
MAXIMUM SPL (9)	108dB peak
NOMINAL IMPEDANCE	16 ohms
DISPERSION (-6dB)	180° conical up to 10kHz
CROSSOVER	3.5 kHz passive (LF and HF auto-resetting fuses)
TRANSFORMER TAPS	70V: 20w / 10w / 5w / 2.5w, 100V: 20w / 10w / 5w
RECOMMENDED HIGH-PASS FILTER	75Hz 24dB/oct
ENCLOSURE	UL 94V-0 rated ABS baffle with steel backcan
FINISH	Baffle and grille: RAL9016 white, Backcan: zinc plated
GRILLE	Perforated steel, powder-coated, bayonet fitting
CONNECTORS	Ceramic connector (in and link) located behind fire-retardant steel cover
ACCESSORIES (included)	2 tile rails, C-ring backing plate, Cut-out template
DIMENSIONS	(OD) 221mm x (D) 98mm (OD) 8.7in x (D) 3.9in
WEIGHT	2.2kg (4.8lbs)

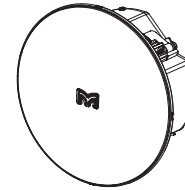

ACS-40TS

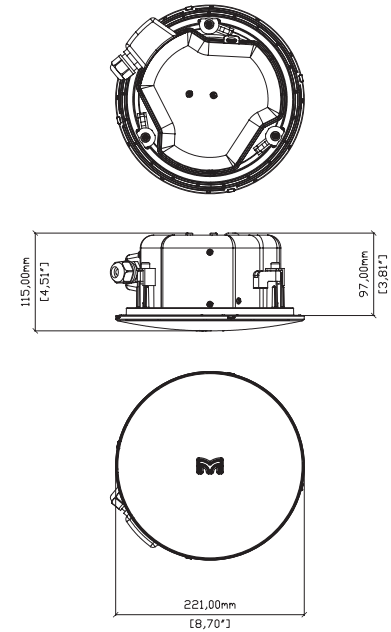

ACS-55TS

TYPE	Compact, passive two-way ceiling speaker, ported bass reflex
FREQUENCY RESPONSE (1)	117Hz-20kHz \pm 3dB, -10dB @ 79Hz
DRIVERS	LF: 5.25" /1" high-temp voice coil, coated paper cone, rubber surround, ferrite motor, pressed steel chassis HF: 0.75" silk dome, neodymium motor
RATED POWER (2)	50W AES, 200W peak
RECOMMENDED AMPLIFIER	VIA2004 (for low-impedance operation)
SENSITIVITY (4)	90dB / 1W(4V) / 1m
MAXIMUM SPL (9)	113dB peak
NOMINAL IMPEDANCE	16 ohms
DISPERSION (-6dB)	150° conical up to 7kHz
CROSSOVER	3kHz passive (LF and HF auto-resetting fuses)
TRANSFORMER TAPS	70V: 30w / 15w / 7.5w / 3.75w, 100V: 30w / 15w / 7.5w
RECOMMENDED HIGH-PASS FILTER	65Hz 24dB/oct
ENCLOSURE	UL 94V-0 rated ABS baffle with steel backcan
FINISH	Baffle and grille: RAL9016 white, Backcan: zinc plated
GRILLE	Perforated steel, powder-coated, bayonet fitting
CONNECTORS	Ceramic connector (in and link) located behind fire-retardant steel cover
ACCESSORIES (included)	2 tile rails, C-ring backing plate, Cut-out template
DIMENSIONS	(OD) 245mm x (D) 102mm (OD) 9.7in x (D) 4in
WEIGHT	2.8kg (6.2lbs)



ACS-55TS

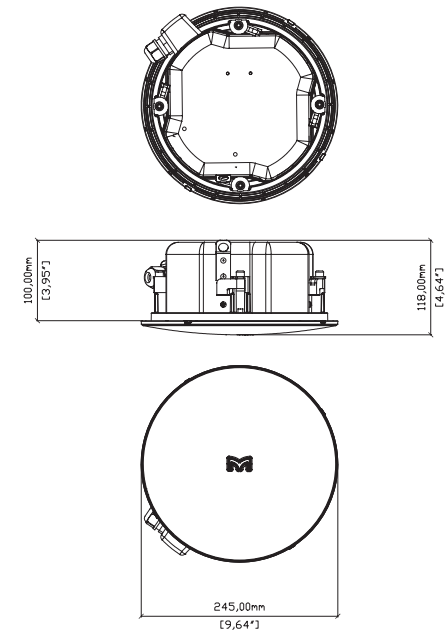

ACS-55T

TYPE	Compact, passive two-way ceiling speaker, ported bass reflex
FREQUENCY RESPONSE (1)	98Hz-20kHz \pm 3dB, -10dB @ 62Hz
DRIVERS	LF: 5.25" / 1" high-temp voice coil, coated paper cone, rubber surround, ferrite motor, pressed steel chassis HF: 0.75" silk dome, neodymium motor
RATED POWER (2)	50W AES, 200W peak
RECOMMENDED AMPLIFIER	VIA2004 (for low-impedance operation)
SENSITIVITY (4)	90dB / 1W(4V) / 1m
MAXIMUM SPL (9)	113dB peak
NOMINAL IMPEDANCE	16 ohms
DISPERSION (-6dB)	150° conical up to 7kHz
CROSSOVER	3kHz passive (LF and HF auto-resetting fuses)
TRANSFORMER TAPS	70V: 30w / 15w / 7.5w / 3.75w, 100V: 30w / 15w / 7.5w
RECOMMENDED HIGH-PASS FILTER	65Hz 24dB/oct
ENCLOSURE	UL 94V-0 rated ABS baffle with steel backcan
FINISH	Baffle and grille: RAL9016 white, Backcan: zinc plated
GRILLE	Perforated steel, powder-coated, bayonet fitting
CONNECTORS	Ceramic connector (in and link) located behind fire-retardant steel cover
ACCESSORIES (included)	2 tile rails, C-ring backing plate, Cut-out template
DIMENSIONS	(OD) 245mm x (D) 193mm (OD) 9.7in x (D) 7.6in
WEIGHT	3kg (6.6lbs)

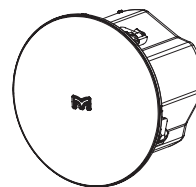

ACS-55T

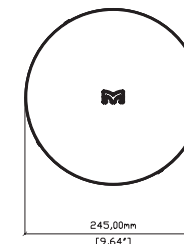
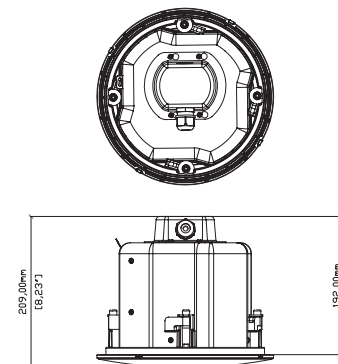

ACP-55T

TYPE	Passive two-way pendant speaker, ported bass reflex
FREQUENCY RESPONSE (6)	98Hz-20kHz \pm 3dB -10dB @ 56Hz
DRIVERS	LF: 5.25" / 1" high-temp voice coil, coated paper cone, rubber surround, ferrite motor, pressed steel chassis HF: 0.75" silk dome, neodymium motor
RATED POWER (2)	50W AES, 200W peak
RECOMMENDED AMPLIFIER	VIA2004 (for low-impedance operation)
SENSITIVITY (7)	86dB / 1W(4V) / 1m (full space)
MAXIMUM SPL (9)	109dB Peak
NOMINAL IMPEDANCE	16 ohms
DISPERSION (-6dB)	150° conical up to 7kHz
CROSSOVER	3kHz passive (LF and HF auto-resetting fuses)
TRANSFORMER TAPS	70V: 30w / 15w / 7.5w / 3.75w 100V: 30w / 15w / 7.5w
RECOMMENDED HIGH-PASS FILTER	65Hz 24dB/oct
ENCLOSURE	UL 94V-0 rated ABS baffle and enclosure
FINISH	Black or white
GRILLE	Perforated steel, powder-coated, bayonet fitting
CONNECTORS	Ceramic connector (in and link)
DIMENSIONS	(OD) 246mm x (D) 157 mm (175mm including grille) (OD) 9.7in x (D) 6.2in (6.9in including grille)
WEIGHT	3.46kg (7.62lbs)



ACP-55T

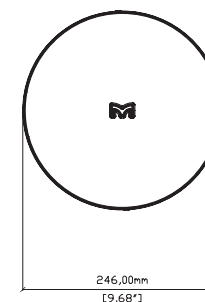
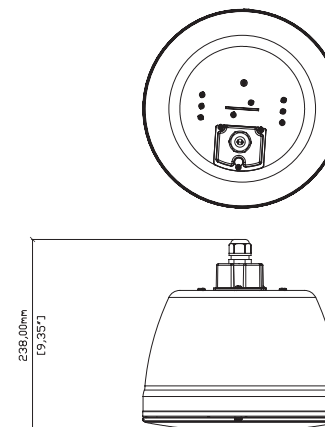

TECHNICAL SPECIFICATIONS

A40/A40T

TYPE	Ultra-compact passive two-way system, front ported bass reflex
FREQUENCY RESPONSE (1)	98Hz-17kHz ± 3dB -10dB @ 70Hz
DRIVERS	LF: 4" / 1" high-temp voice coil, coated paper cone, rubber surround, ferrite motor, pressed steel chassis HF: 0.75" silk dome, neodymium motor
RATED POWER (2)	40W AES, 160W peak
RECOMMENDED AMPLIFIER	A40: VIA2004 A40T: VIA5002
SENSITIVITY (1)	87dB/1W/1m
MAXIMUM SPL (9)	109dB peak
NOMINAL IMPEDANCE	16 ohms
DISPERSION (-6dB)	110° H x 80° V
CROSSOVER	3.5kHz passive (LF and HF auto-resetting fuses)
TRANSFORMER TAPS (A40T only)	70V: 20w / 10w / 5w / 2.5w 100V: 20w / 10w / 5w
RECOMMENDED HIGH-PASS FILTER	60Hz 24dB/oct
ENCLOSURE	ABS, UL 94V-0 rated
FINISH	Black or white
GRILLE	Perforated steel
CONNECTORS	Push terminals
FITTINGS	Wall bracket included
DIMENSIONS EXCL. BRACKET	(W) 124mm x (H) 200mm x (D) 114mm (W) 4.9in x (H) 7.9in x (D) 4.5in
WEIGHT	A40: 1.75kg (3.9lbs) A40T: 2.13kg (4.7lbs)
ACCESSORIES	Waterproof connector cover

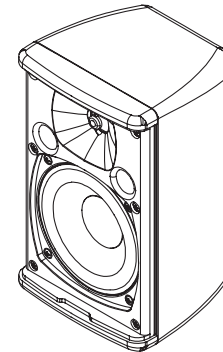
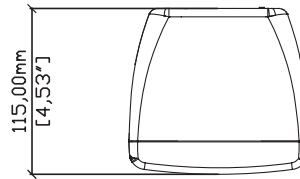

Notes

- (1) Measured on-axis in half (2pi) space at 2 metres, then referred to 1 metre.
- (2) AES Standard ANSI S4.26-1984.
- (3) Measured in half (2pi) space at 2 metres with 1 watt input, using band limited pink noise, then referred to 1 metre.
- (4) Measured in half (2pi) space at 2 metres using band limited pink noise, then referred to 1 metre.
- (5) Measured on-axis in open (4pi) space at 2 metres, then referred to 1 metre.
- (6) Measured in open (4pi) space at 2 metres with 1 watt input, using band limited pink noise, then referred to 1 metre.
- (7) Measured in open (4pi) space at 2 metres using band limited pink noise, then referred to 1 metre.
- (8) Measured in open (4pi) space at 2 metres with 2.83v input, using band limited pink noise, then referred to 1 metre.
- (9) Calculated at 1 metre.
- (10) Measured in half (2pi) space at 2 metres with 2.83v input, using band limited pink noise, then referred to 1 metre.

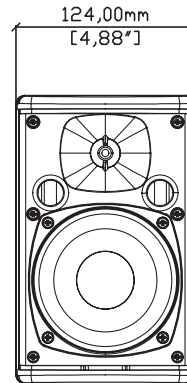
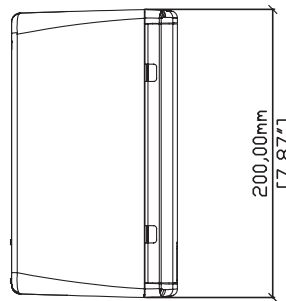

A40

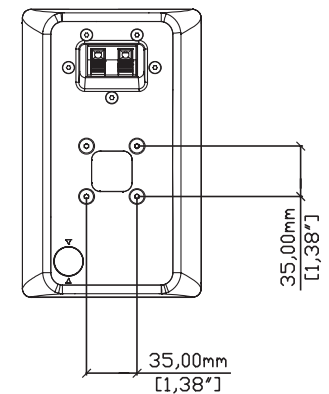
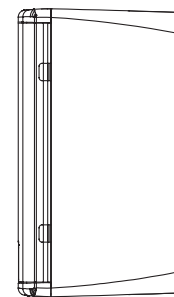

A55/A55T

TYPE	Ultra-compact passive two-way system, front ported bass reflex
FREQUENCY RESPONSE (1)	90Hz-17kHz ± 3dB -10dB @ 65Hz
DRIVERS	LF: 5.25" /1" high-temp voice coil, coated paper cone, rubber surround, ferrite motor, pressed steel chassis HF: 0.75" silk dome, neodymium motor
RATED POWER (2)	50W AES, 200W peak
RECOMMENDED AMPLIFIER	A55: VIA2004 A55T: VIA5002
SENSITIVITY (1)	90dB/1W/1m
MAXIMUM SPL (9)	113dB peak
NOMINAL IMPEDANCE	16 ohms
DISPERSION (-6dB)	110° H x 80° V
CROSSOVER	3.5kHz passive (LF and HF auto-resetting fuses)
TRANSFORMER TAPS (A55T only)	70V: 30w / 15w / 7.5w / 3.75w 100V: 30w / 15w / 7.5w
RECOMMENDED HIGH-PASS FILTER	60Hz 24dB/oct
ENCLOSURE	ABS, UL 94V-0 rated
FINISH	Black or white
GRILLE	Perforated steel
CONNECTORS	Push terminals
FITTINGS	Wall bracket included
DIMENSIONS EXCL. BRACKET	(W) 152mm x (H) 245mm x (D) 140mm (W) 6in x (H) 9.6in x (D) 5.5in
WEIGHT	A55: 2.21kg (4.9lbs) A55T: 2.81kg (6.2lbs)
ACCESSORIES	Waterproof connector cover

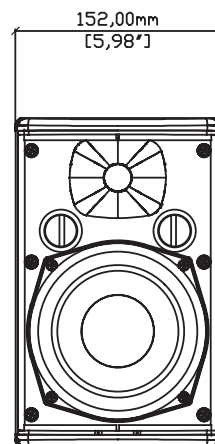
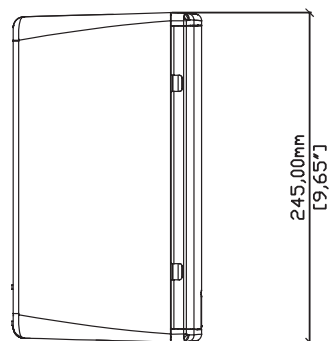
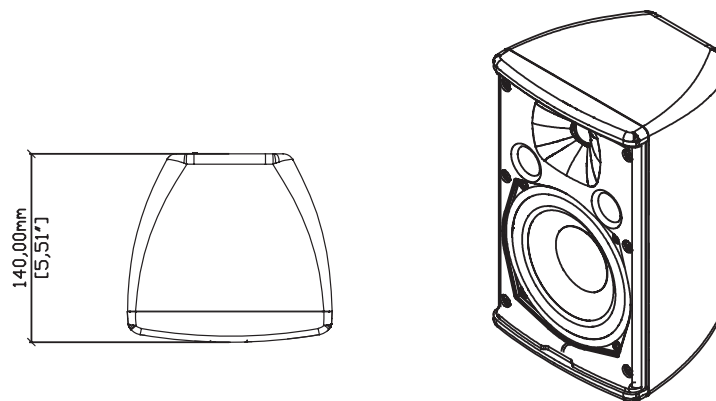

A55

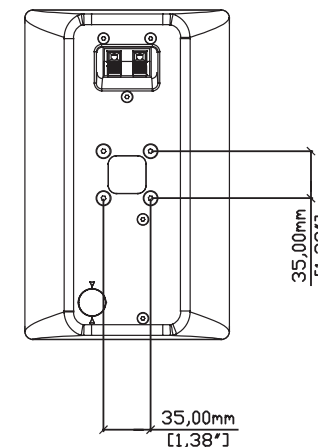
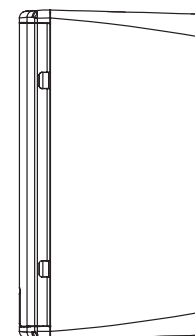

ADORN

SIGNATURE SOUND FOR COMMERCIAL
INSTALLATION APPLICATIONS

Martin Audio Limited

Century Point

Halifax Road

Cressex Business Park

High Wycombe

Buckinghamshire

HP12 3SL

England

FOR SALES ENQUIRIES:

UK

Telephone: +44 (0)1494 535312

E-mail: info@martin-audio.com

NORTH AMERICA

Telephone: 323 381 5310

www.martin-audio.com

All information is Copyright © 2020 Martin Audio Ltd.

Martin Audio, the Martin Audio logo and Hybrid are registered trademarks of Martin Audio Ltd. in the United Kingdom, United States and other countries; all other Martin Audio trademarks are the property of Martin Audio Ltd.



Unite Your Audience
The Martin Audio Experience



Version 2.1